

**MAIN POINT:**

Jesus Knows Everyone; He is God.

**MEMORY VERSE:**

*"The Son is the exact likeness of God, who can't be seen. The Son is first, and he is over all creation."*  
Colossians 1:15

**BIBLE STORY SUMMARY:**

Jesus chose twelve men to be His disciples. These were ordinary men, that Jesus chose for extraordinary purposes. When Jesus called them to follow Him, they immediately did. These men were His closest friends. Jesus calls us too and wants to be friends with us. He knows everything about us. Jesus knows everyone!

**WATCH IT**

Find the lesson video on our website: <https://cchurch.ca/childrens-online>

**DO IT → APOSTLE FLIP BOOK**

**Supplies:**

- Apostle book templates (1 per child, see last pages)
- Glue sticks
- Scissors
- Crayons or markers

**Activity Instructions:**

- Print and cut out the craft templates. Leave the white blocks beside the apostle pictures. Do not cut between the pictures yet.
- Colour as desired. (There are three covers on the page, but they will only need to colour one.)
- Note: Some of these folds are "forward" folds, which means children can't see the line they're folding. Have the child fold back on the line, and then fold it forward to make it simpler.
- Have children start by folding their cover along the lines. They will need to fold the book in half first, and then fold the front and back covers back to create a spine. (picture on next page)

Continued on next page →



- Fold the block beside the pictures, in toward the pictures. Then cut between the body segments, stopping before you get to the side blocks.

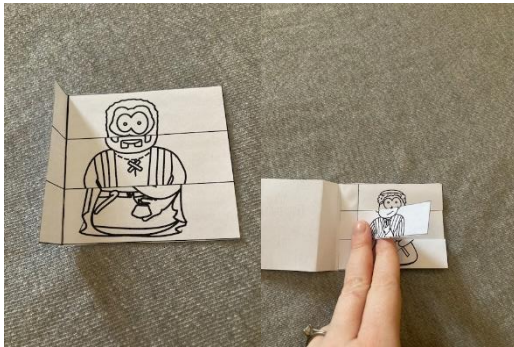

- Line up the side block into the “spine” part of the cover. There will be a bit of extra space. Leave the space toward the centre line, as it will “fill in” as you stack the apostles. As you glue down each apostle, fold back the pieces to make sure that none are stuck before you add the next level. Glue the spine closed once you’re finished.

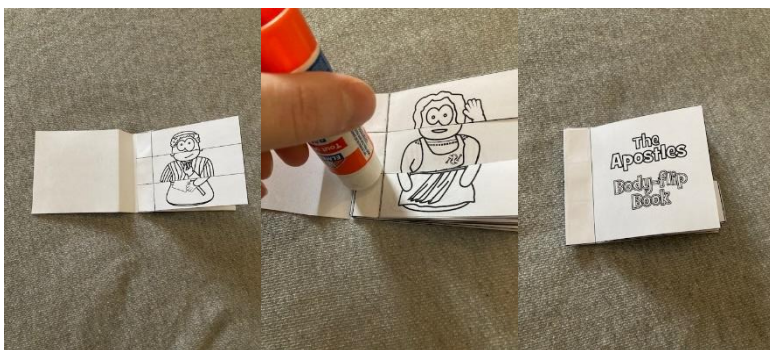

### The Point

Your apostle flip book can remind you about the names of the disciples and that Jesus knows everyone, not just the disciples but you, too!

*Continued on next page →*

## TALK ABOUT IT:

Do this section with your child while they are assembling their craft.

1. **Which of your friends or family knows you better than anyone?** (Parent, best friend, sister/brother)
2. **The disciples knew Jesus better than anyone. And Jesus Knows Everyone! That means He knows everything about you. What do you think is the coolest thing that Jesus knows about you that no one else does (maybe even you!)?** (How many hairs are on your head. Who you've said the most words to. How many books you've read in your life.

**When someone knows us really well, it makes them easier to trust because we know they understand our thoughts and our feelings. They know how we will react to situations and what sorts of things we might feel sensitive about. We can trust Jesus because Jesus Knows Everyone. Why do you like about the fact that Jesus knows you so well?** (It helps you trust Him. It feels good to be known and understood).













## FAMILY PRAYER:













**Dear God, thank You for giving us Jesus. Thank You that Jesus knows everyone. We want to know Jesus as our close friend. In Jesus' name, Amen.**













## OFFERING:

Our Children's Ministries offering from January to March will be going to our Compassion Kids! Lluvia and Ulises live in Mexico, and our offering will help provide them with clothes, school supplies, and other important items.

*Continued on next page →*

 Peter	 James	 John	 Andrew			<h1>The Apostles</h1> <h2>Body-flip Book</h2>
 Philip	 Thomas	 Nathanael	 Matthew			
 James	 Simon	 Jude	 Judas			

 Peter	 James	 John	 Andrew			<h1>The Apostles</h1> <h2>Body-flip Book</h2>
 Philip	 Thomas	 Nathanael	 Matthew			
 James	 Simon	 Jude	 Judas			

 Peter	 James	 John	 Andrew			<h1>The Apostles</h1> <h2>Body-flip Book</h2>
 Philip	 Thomas	 Nathanael	 Matthew			
 James	 Simon	 Jude	 Judas			

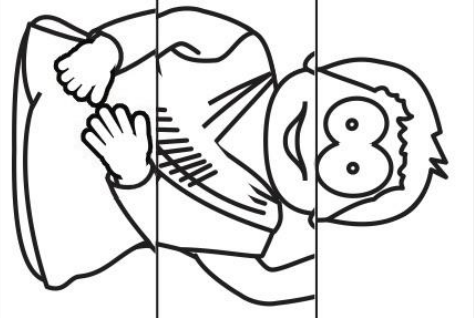
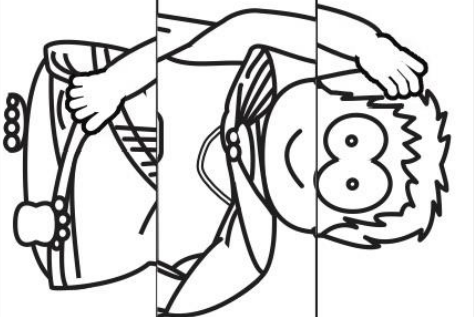
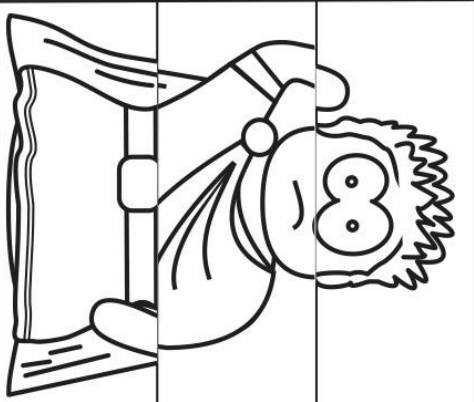

**James Nathanael Judas Peter Andrew John**

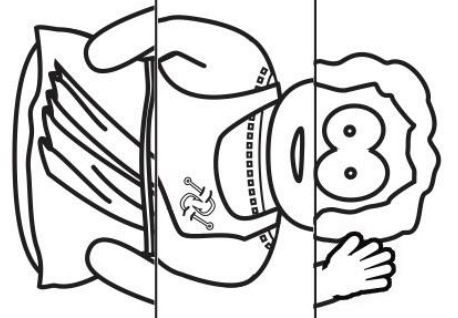
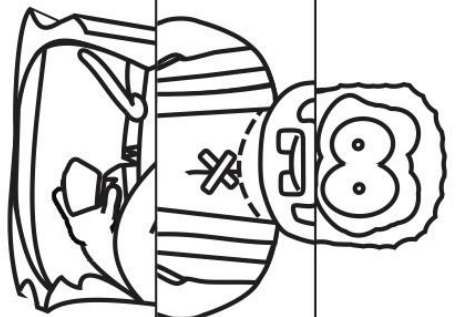
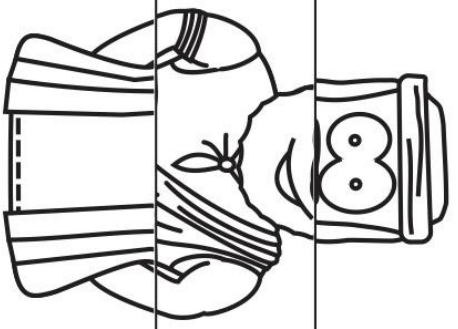



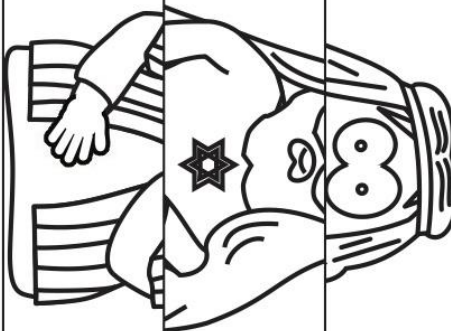
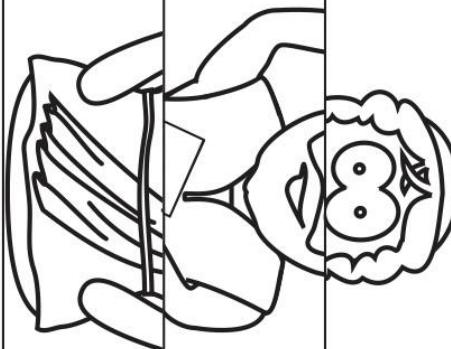
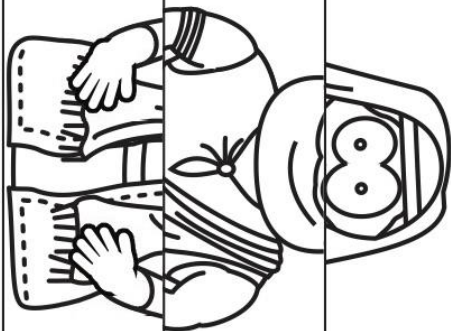

**Thomas Matthew Jude Simon Philip James**

